

Sealed to structure using MS Polymer sealant

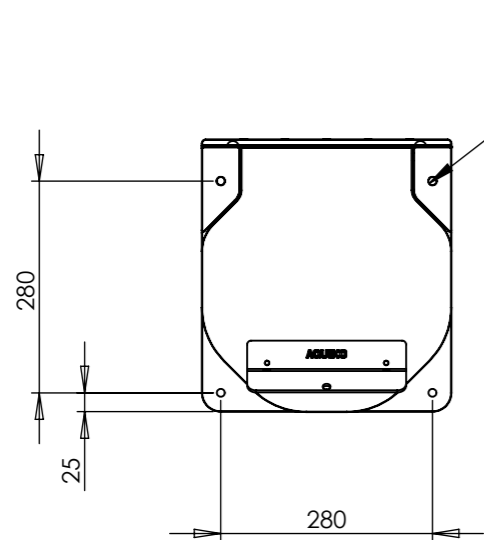

Fixed to structure using M8 A4 anchor rods and resin

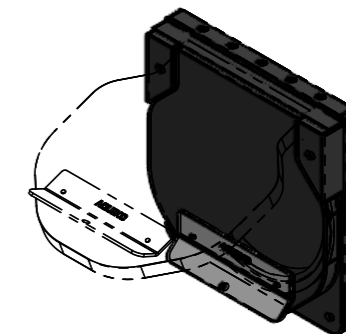
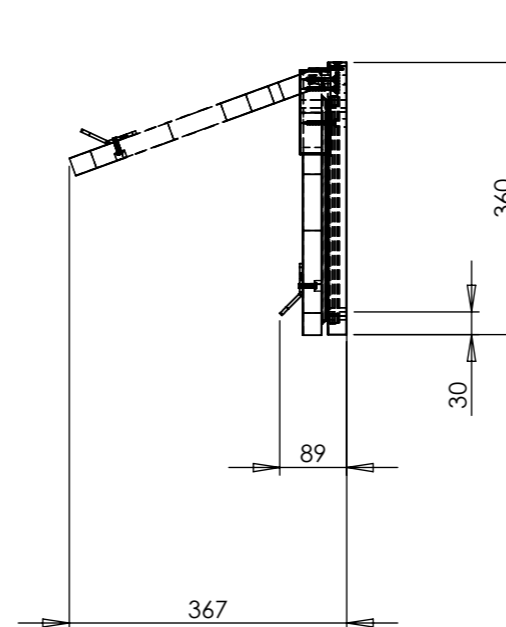

Surface tolerance of sealing wall to be 2-3mm per linear metre.



NAME	DATE
DRAWN JC	2/2/21
CHK'D JC	2/2/21
APPV'D	

DO NOT SCALE DRAWING
UNLESS OTHERWISE SPECIFIED: DIMENSIONS ARE IN MILLIMETERS LINEAR, ANGULAR AND EDGE TOLERANCES ARE TO ACE DOC. DRAWING STANDARDS-2018-JC-0

TITLE: 250-ARF

WEIGHT (kg): 5

Material: HDPE and Stainless Steel 316

SCALE 1:10

REVISION 0